

Copyright
Do not scale from this drawing
Contractors must confirm site dimensions
before starting work or shop drawings

Ref	Description	Date	Auth By
	FOR PLANNING	18.12.00	

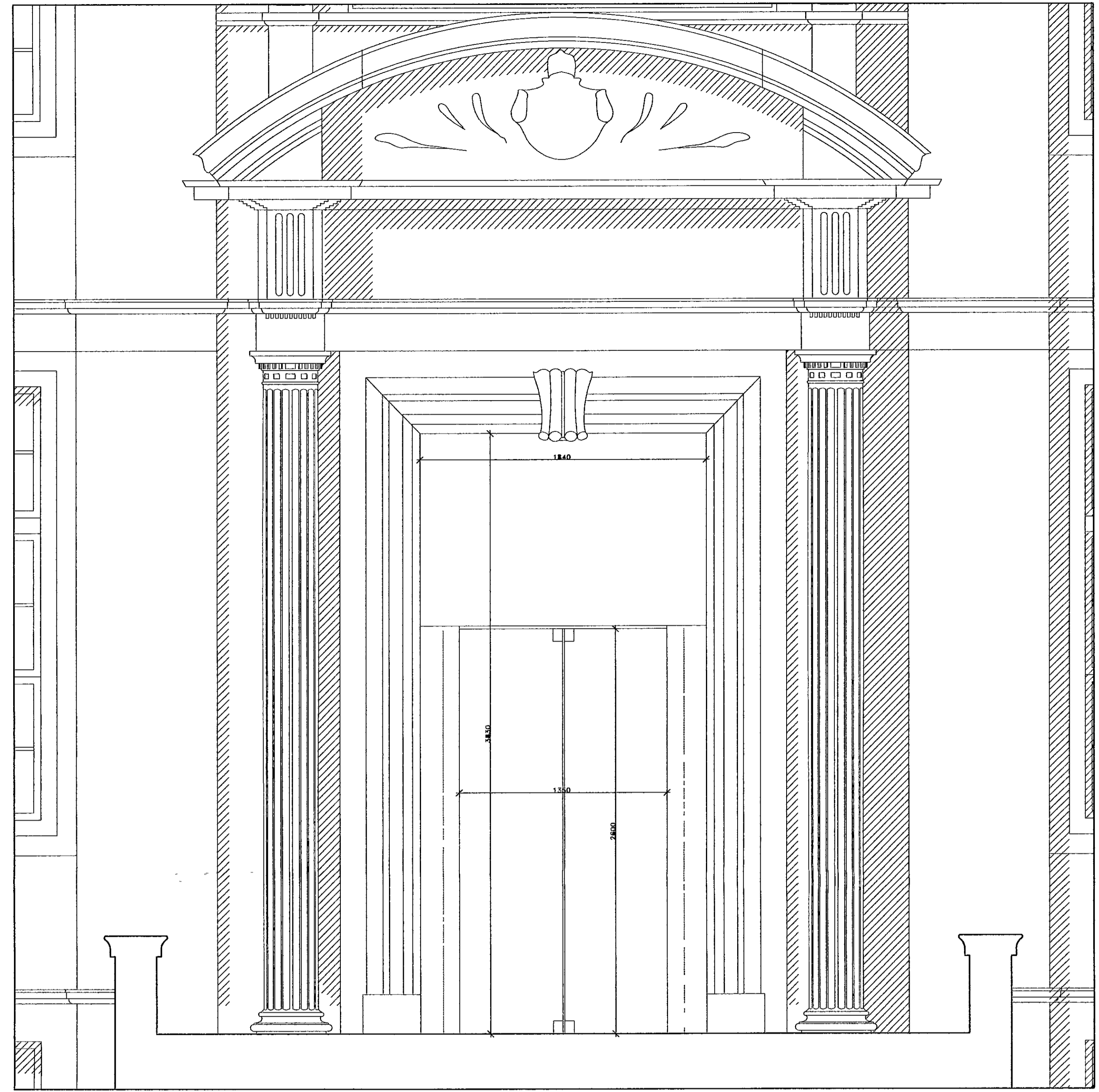

PROPOSED REVOLVING DOOR ELEVATION

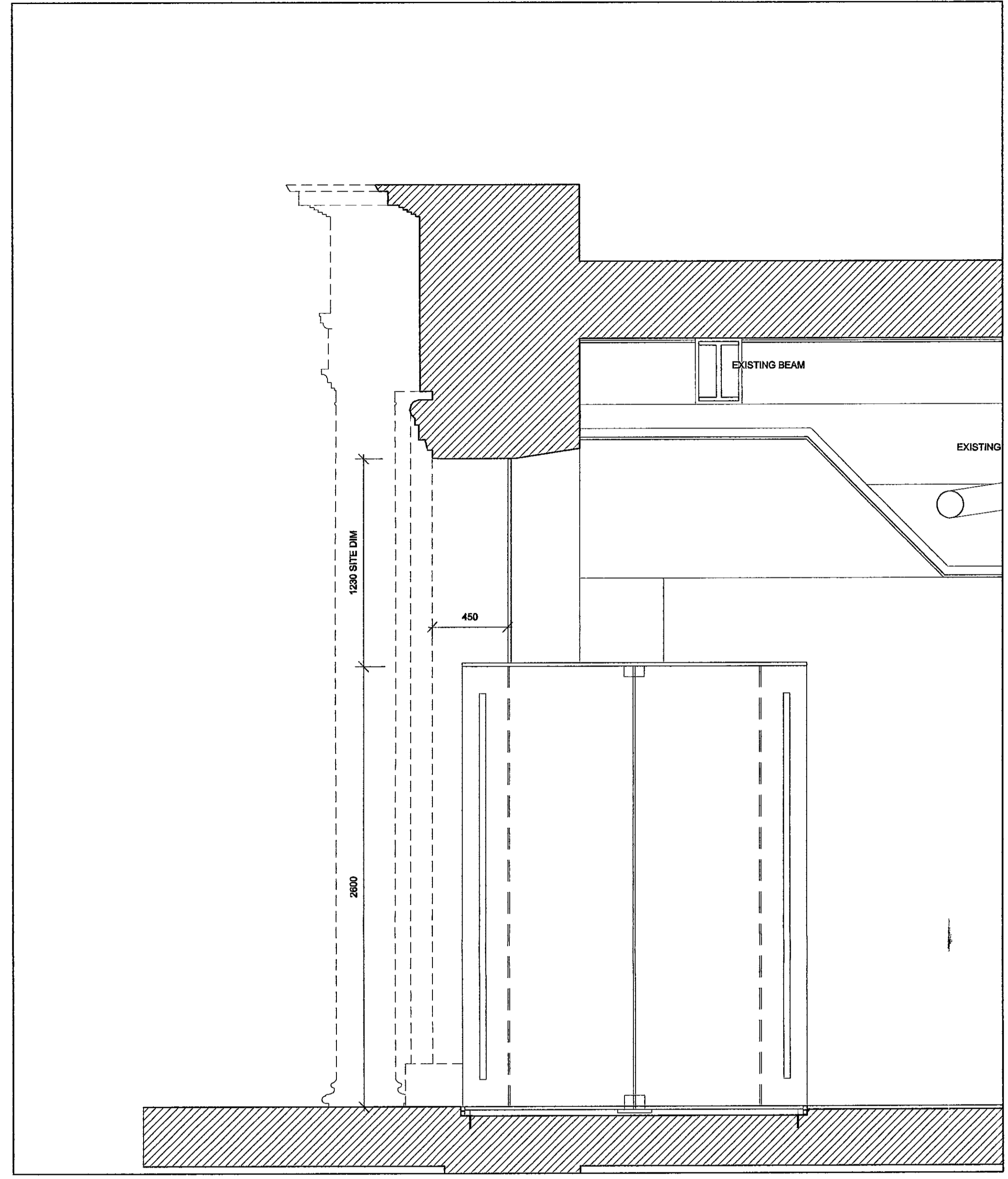

PROPOSED REVOLVING DOOR SECTION

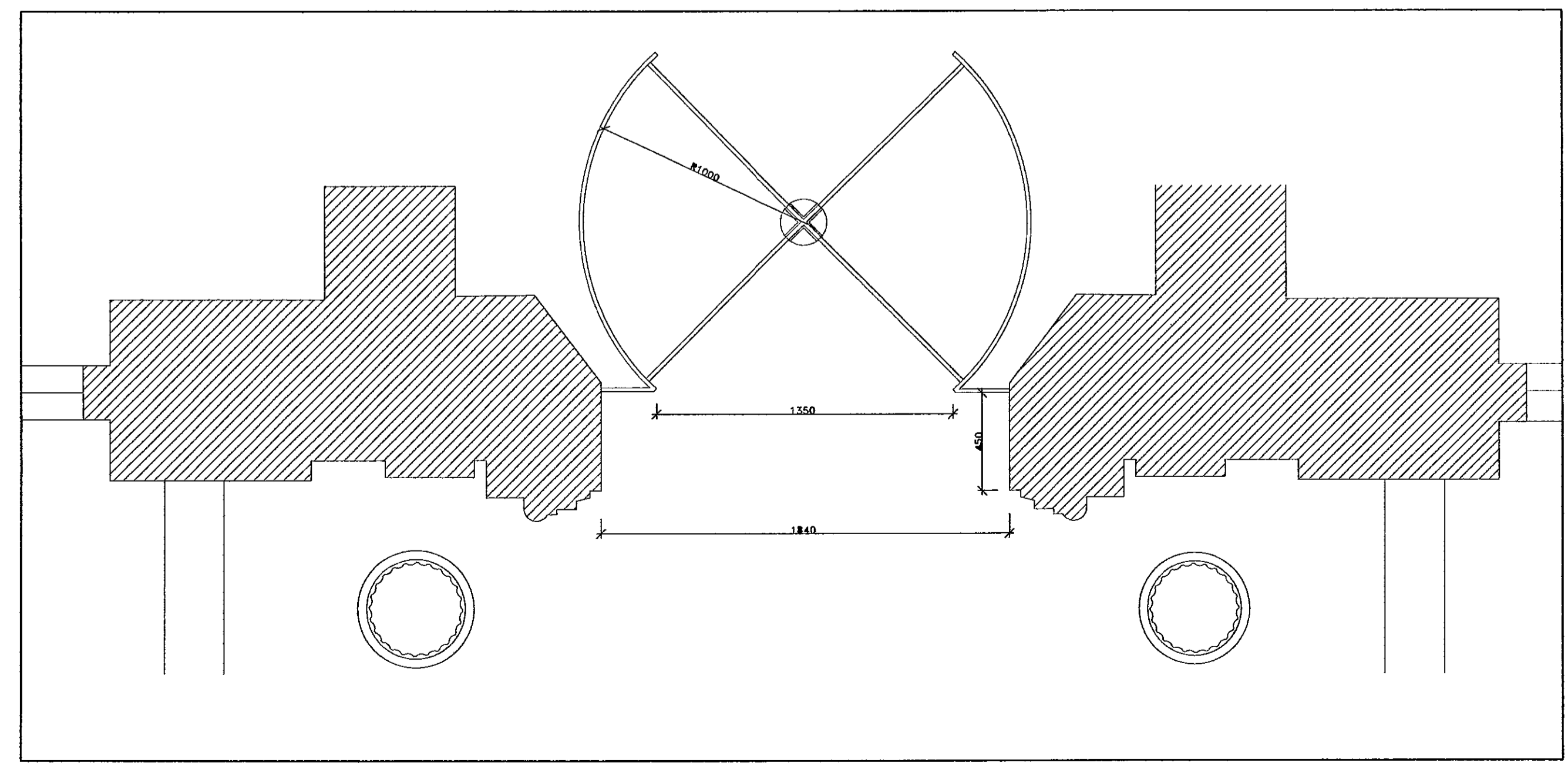

PROPOSED REVOLVING DOOR PLAN

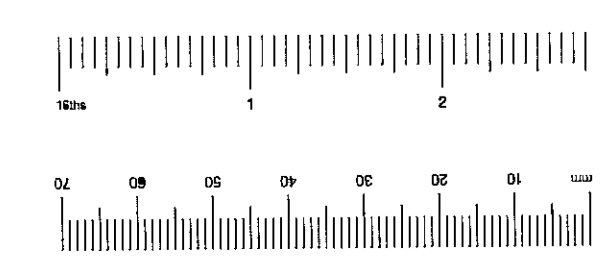

R.B.K. & C.
TOWN PLANNING
20 DEC 2000
RECEIVED

PF002908

PLANNING
Gibberd
ARCHITECTURE AND DESIGN

117-121 Curzon Road, Fulham, London SW3 6DA, 3AD
Telephone 020 7739 3400 Fax 020 7739 8848
Email studio@gibberd.com

Project
RMH RECEPTION
FULHAM ROAD
Client
ROYAL MARSDEN HOSPITAL
NHS TRUST

Title
REVOLVING DOOR
DETAILS
Scale 1:20 Date 18.12.00 Drawn By NSF
Doc No G0313 DWG Plot Date 18.12.00 Authorised By
Project No G0313 Drawing No [PA]02 Revision

Client	Project	Sheet	AS	Arch	Draw	Rev	Auth	Rev

SUPERSEDED

Copyright
Do not scale from this drawing
Contractors must confirm site dimensions
before starting work or shop drawings

Revisions
No. Description Date Auth. By
FOR PLANNING 18.12.00
A EXISTING FANLIGHT RETAINED 01.03.01



PROPOSED REVOLVING DOOR ELEVATION

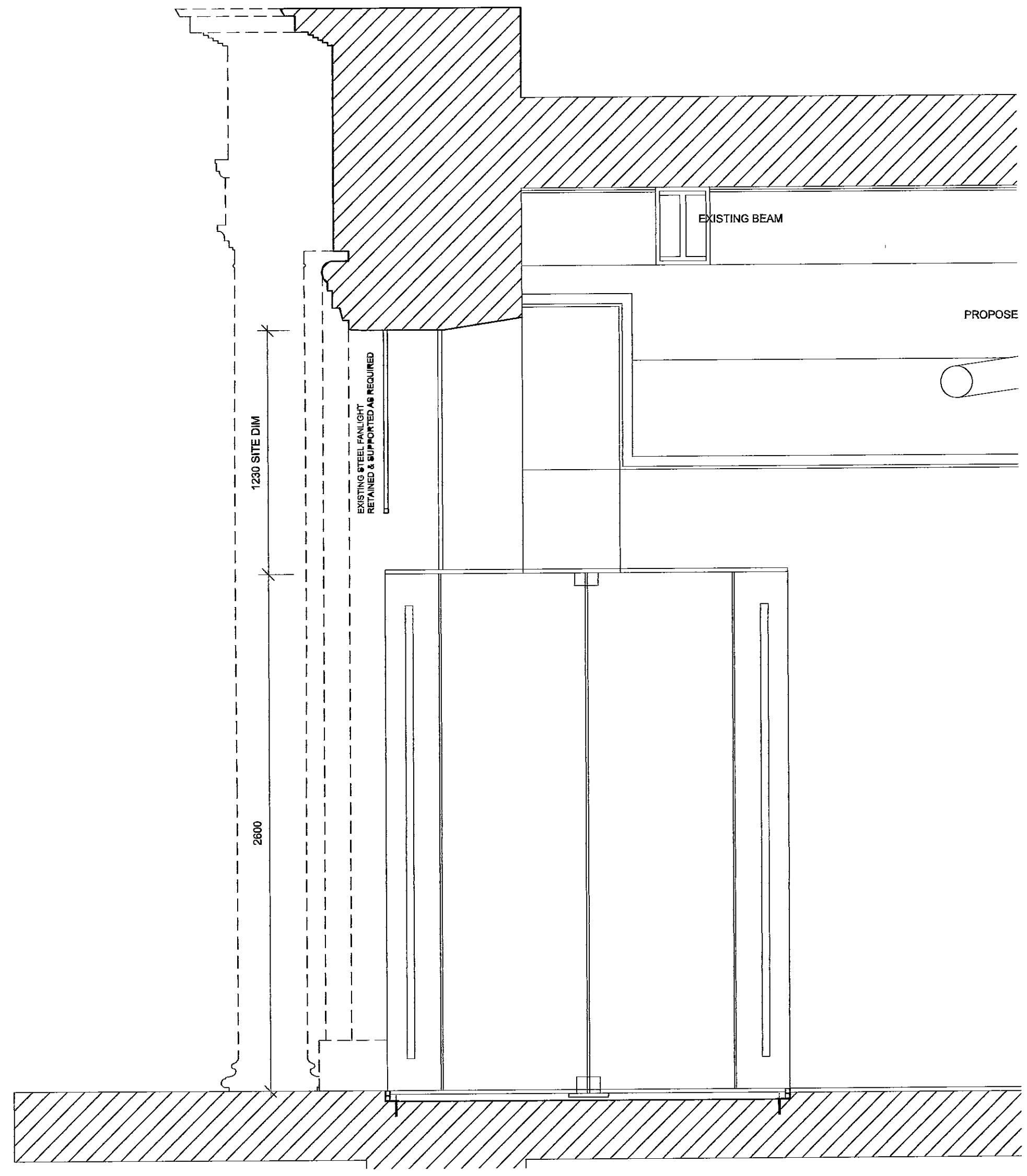

PROPOSED REVOLVING DOOR SECTION

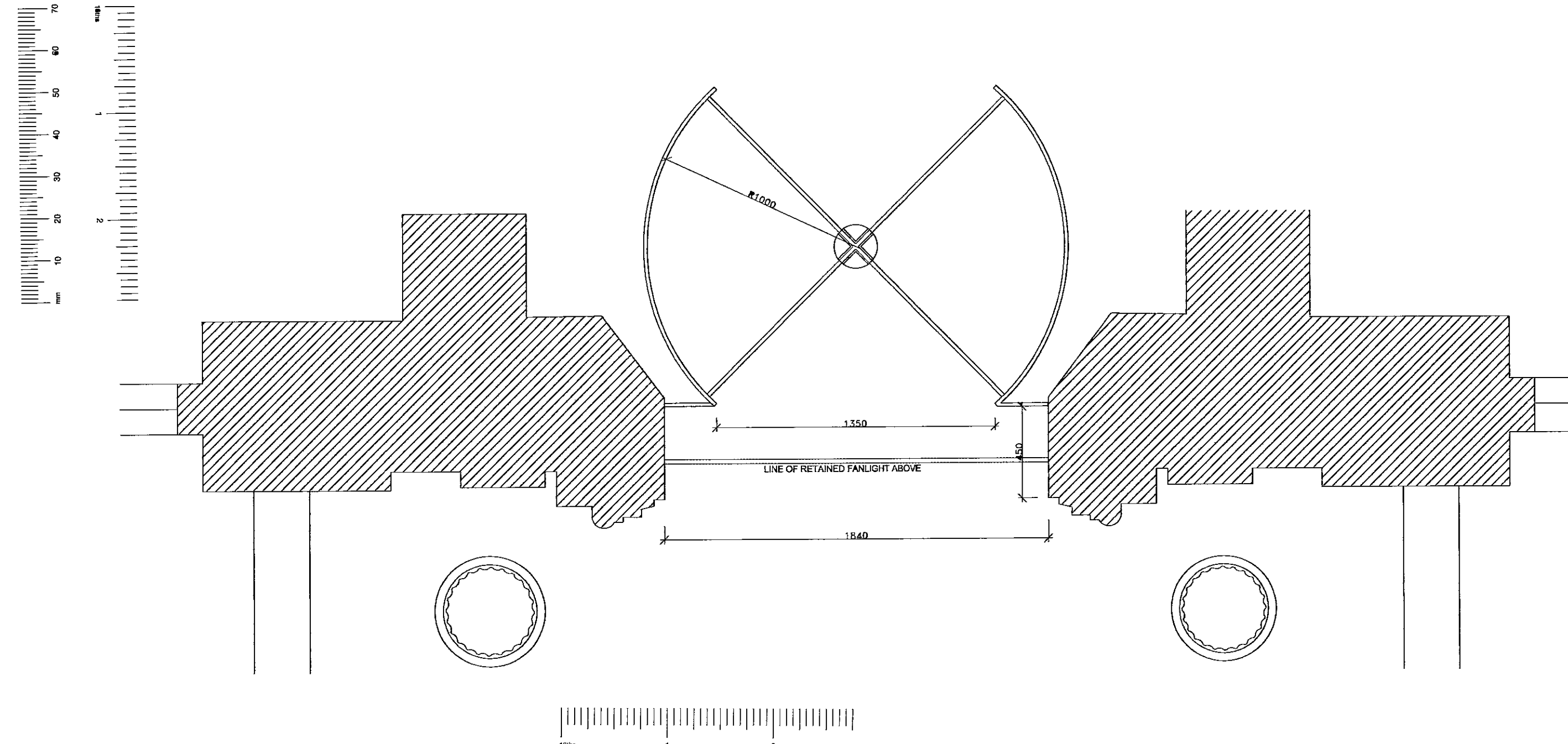

PROPOSED REVOLVING DOOR PLAN

R.B.K. & C.
TOWN PLANNING
- 8 MAR 2001
RECEIVED

DELEGATED
APPROVAL
13 MAR 2001

REVISED
PP/00/2908/A

PLANNING
Gibberd
ARCHITECTURE AND DESIGN
117-121 Curtain Road London EC2A 3AD
Telephone 020 7739 3400 Fax 020 7739 8948
Email studio@gibberd.com

Project
RMH RECEPTION
FULHAM ROAD

Client
ROYAL MARSDEN HOSPITAL
NHS TRUST

Title
REVOLVING DOOR
DETAILS

Scale	Date	Drawn By
1:20	18.12.00	NSF
Dwg No.	Plot Date	Authorised By
G0313 DWG	18.12.00	
Project No	Drawing No	Revision
G0313	[PA]02	A

Client	Project	Sheet	OS	Scale	Dist	Proj	Acct	Dist
ME	001	C of W						

Copyright
Do not scale from this drawing
Contractors must confirm site dimensions
before starting work or stop drawings

Ref	Description	Date	Auth By
	FOR PLANNING	18 12 00	

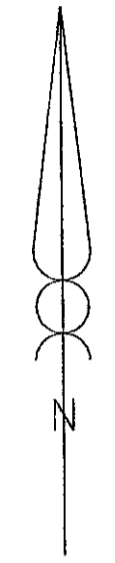

FULHAM ROAD

VIEW ONE CAMERA POSITION

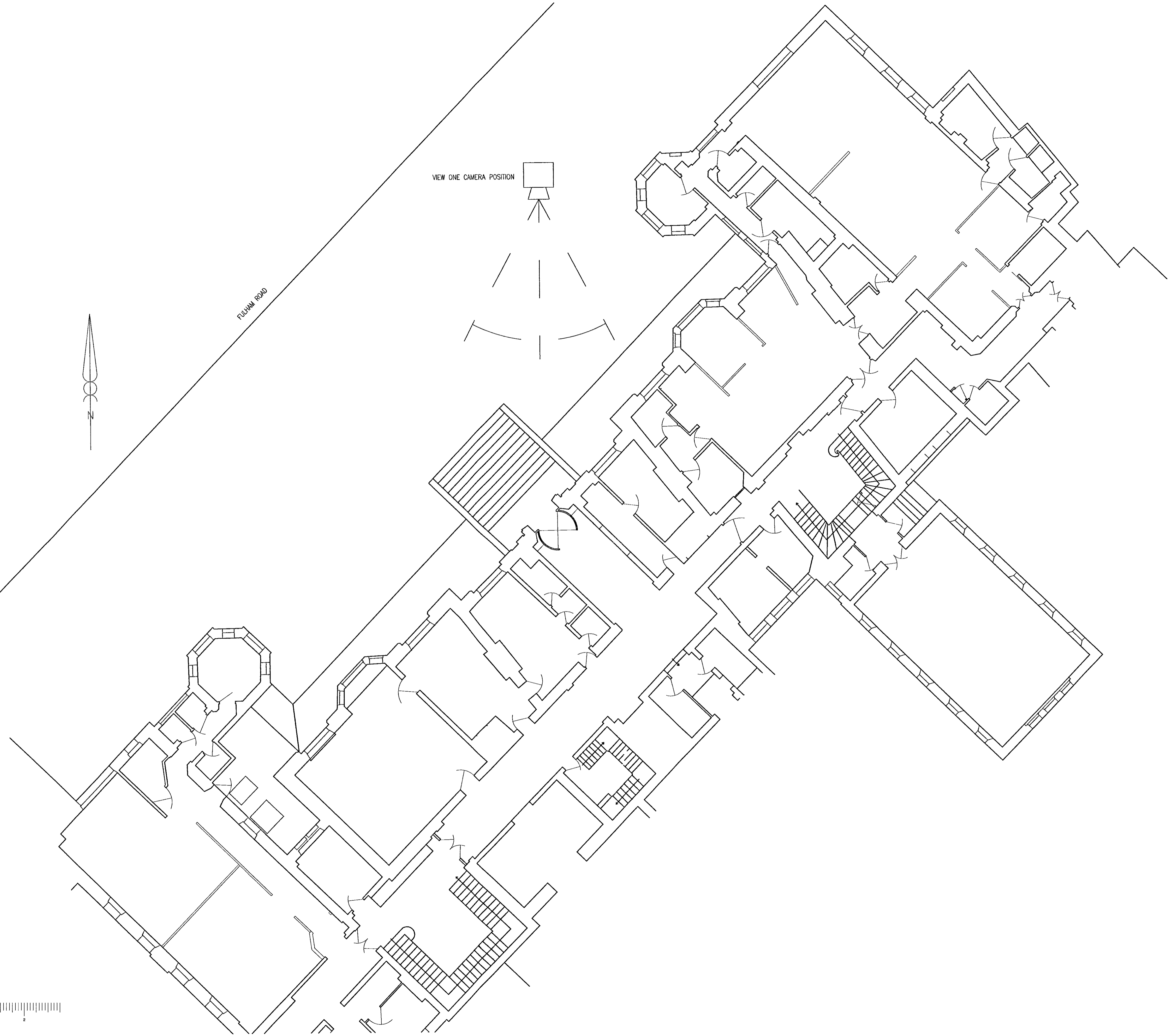
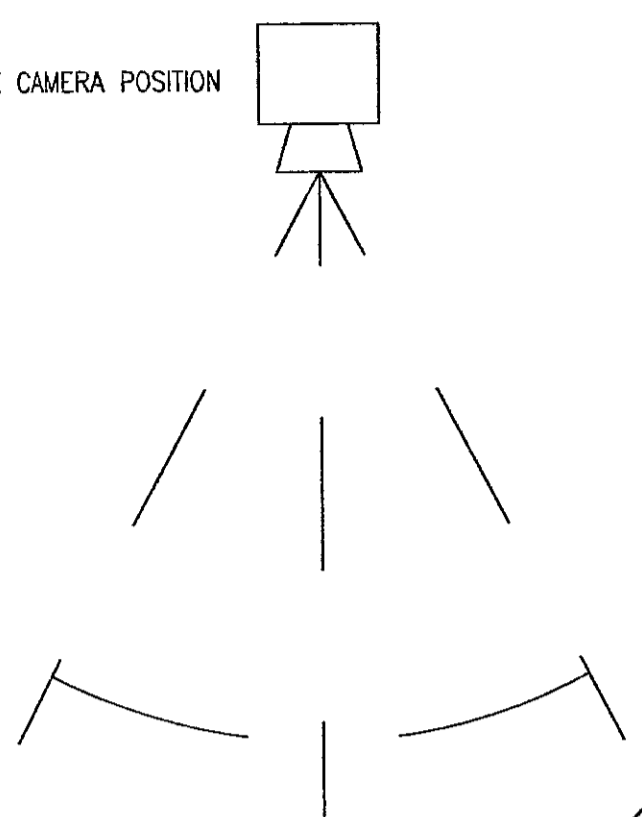

R.B.K. & C.
TOWN PLANNING
24 DEC 2000
RECEIVED

DELEGATED
APPROVAL
13 MAR 2001

PF002903

PLANNING
Gibberd
ARCHITECTURE AND DESIGN

117-121 Curtain Road London EC2A 3AD
Telephone 020 7739 3400 Fax 020 7739 8948
Email studio@gibberd.com

Project
RMH RECEPTION
FULHAM ROAD
Client
ROYAL MARSDEN HOSPITAL
NHS TRUST
Title
PLAN

Scale	Date	Drawn By
1:100	18 12 00	AJC
Dwg No	Plot Date	Authorised By
G0313 DWG	18 12 00	
Project No	Drawing No.	Revision
G0313	PA 03	

Client	Project	Drawn	OS	Scale	Plot	Rev	Author	On
Ref	Site	Arch	C	M	W			Contr
MC	Site	C	M	W				

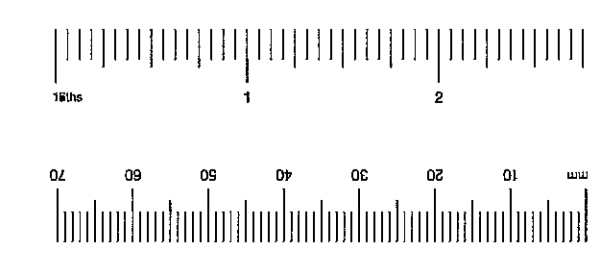
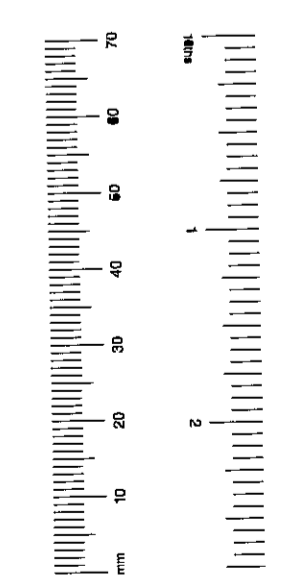

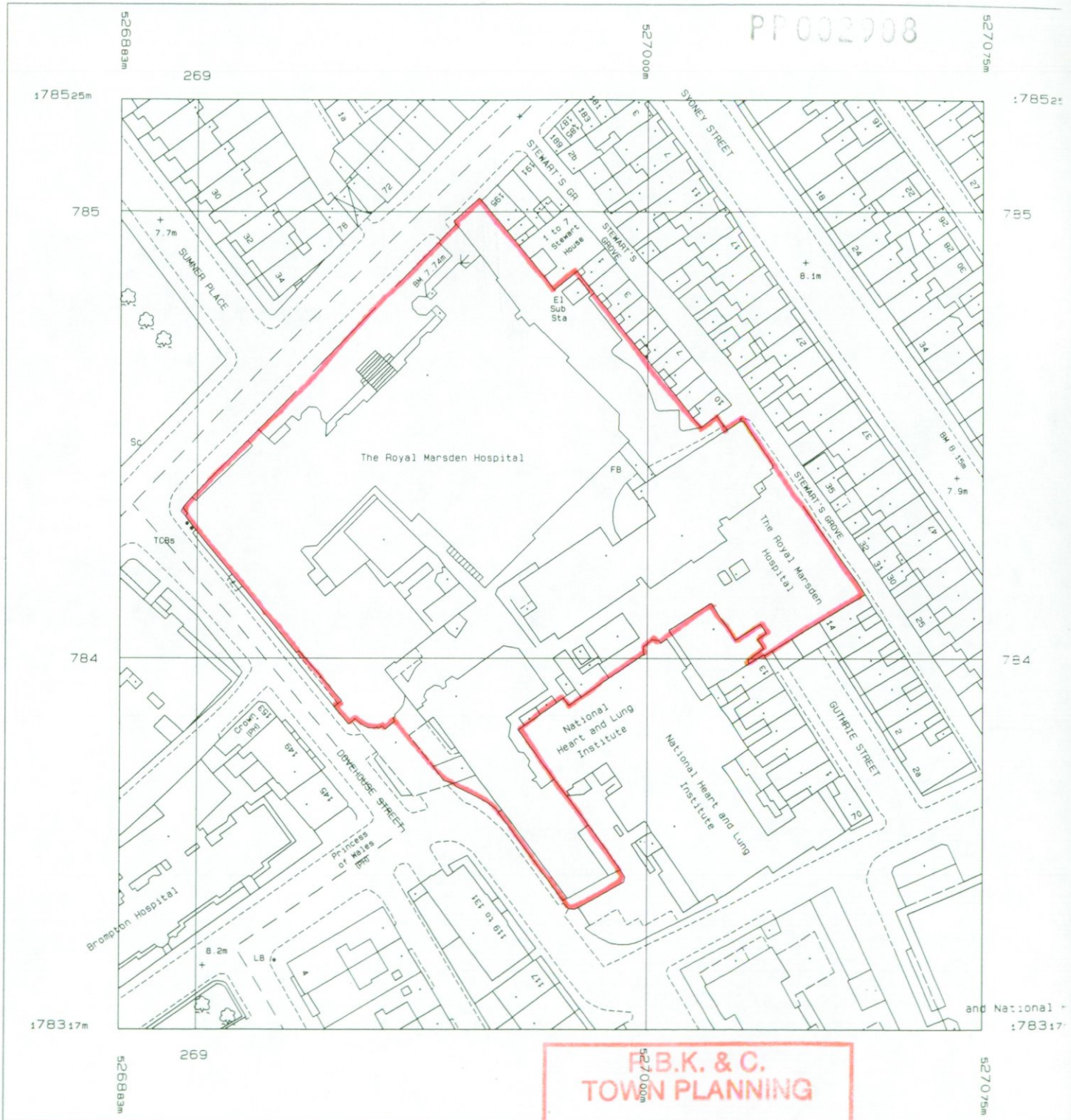

Produced 11 Dec 2000 from Ordnance Survey digital data and incorporating surveyed revision available at this date. © Crown Copyright 2000.

Reproduction in whole or in part is prohibited without the prior permission of Ordnance Survey.

Ordnance Survey, the OS symbol and Superplan are registered trade marks of Ordnance Survey, the national mapping agency of Great Britain.

Scale 1: 1250

National Grid sheet reference at centre of this Superplan: TQ2678SE
 The representation of a road, track or path is no evidence of a right of way.
 Heights are given in metres above Datum.